

## Next generation Long Range Modular Multifunction 24GHz Radar Sensor

Sycra®'s Artis series of sensors is the latest generation of advanced radar sensor which includes the environmental monitoring, light intensity and human presence detection.

It can be fully customized based on the needs of building.

Artis A40L sensor can insure collection of complex information such as people motion, human presence, ambient light, temperature, air humidity, atmospheric pressure, and indoor air quality (IAQ), total volatile organic compound (TVOC), CO<sub>2</sub>, odors and noise.

All those information are analyzed and implemented by Odin station to optimize building automation and maximize energy savings and operations.

Artis A40L also supports Over-The-Air (OTA) and Device Management (DM) protocols to perform monitoring, maintenance and Firmware updates.

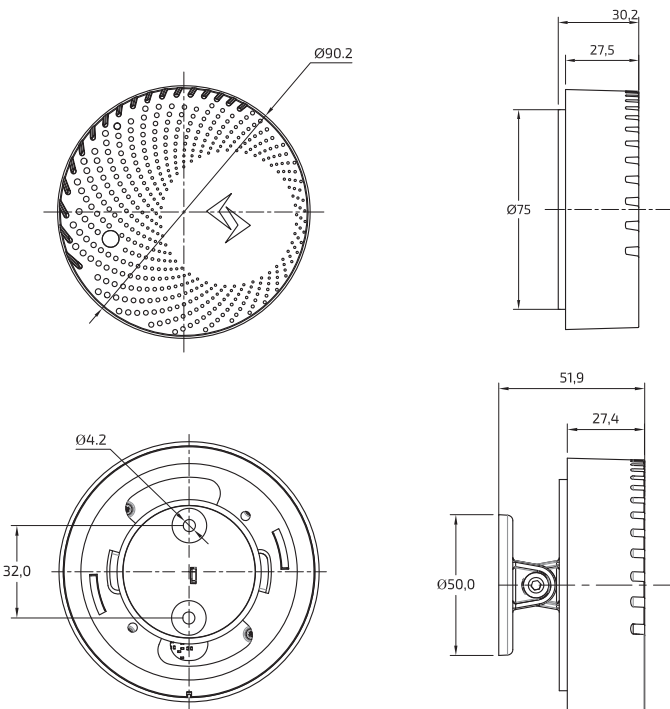

Note: Dimensions graph unit: mm

## Features

- People motion sensing
- Human presence detection
- Working in any weather and environments
- Compact dimensions
- Modular design
- Fast and easy installation
- Wireless Mesh OTA system setup and firmware update
- Wireless Mesh system setup and data transmission: people motion and presence, illumination, temperature, humidity, air pressure
- Lower layer in IoT System

## Applications

- Building Automation
- Greenhouse
- Smart Garden
- Traffic and Street Lights
- Industrial Facilities
- Wireless Mesh Node

## 24GHZ RADAR SENSOR

# ARTIS A40L

## Technical data

Input constant voltage	12-48Vdc/ 5V(Optional)
Input current	16-49mA/ -98mA(Optional)
Wireless Operation frequency	2.4 - 2.48 GHz
Wireless Transmission power	+8dbm
Wireless Mesh Range	~30m (outdoor)
Operated temperature	-20°C~+70°C
Max. case temperature	85°C
Storage temperature	-30°C~+85°C
Relative humidity	10%-90%, non-condensing
Ingress Protection	IP20
Finishes	ABS White
Weight	~110g
Size	ø90.2xH30.2mm
Installation	Wall/Ceiling
<b>Ambient Light Sensor</b>	0~20.000 lux
<b>Radar sensor</b>	
Max. Motion detection distance	~16m (Wall mount)
Radar frequency	24-24.25GHz
Radar modulation	CW
Radar transmit power	3dbm
Detection direction	Horizontal ±57° (Half angle) Vertical ±24° (Half angle)
<b>Ambient Sensor (Optional)</b>	
Temperature	-40°C~+85°C
Humidity	0 % to 100 %RH ±3%RH
Atmospheric Pressure	300 - 1100hPa ±1.7hPa
Noise	30-90dB
<b>Gas (Optional)</b>	
IAQ	UBA <sup>1</sup> and PBAQ <sup>2</sup> standards
CO <sub>2</sub>	400-5000ppm
TVOC	1 to 2000 µg/m <sup>3</sup>

1: UBA. German Federal Environmental Agency Umweltbundesamt

2: PBAQ. Public Building Air Quality standards

## Ceiling mounted radar range

Default sensitive value, unit: m. it's suggested install on the ceiling at around 2.8m. The radar detects area showed as below graph for a reference

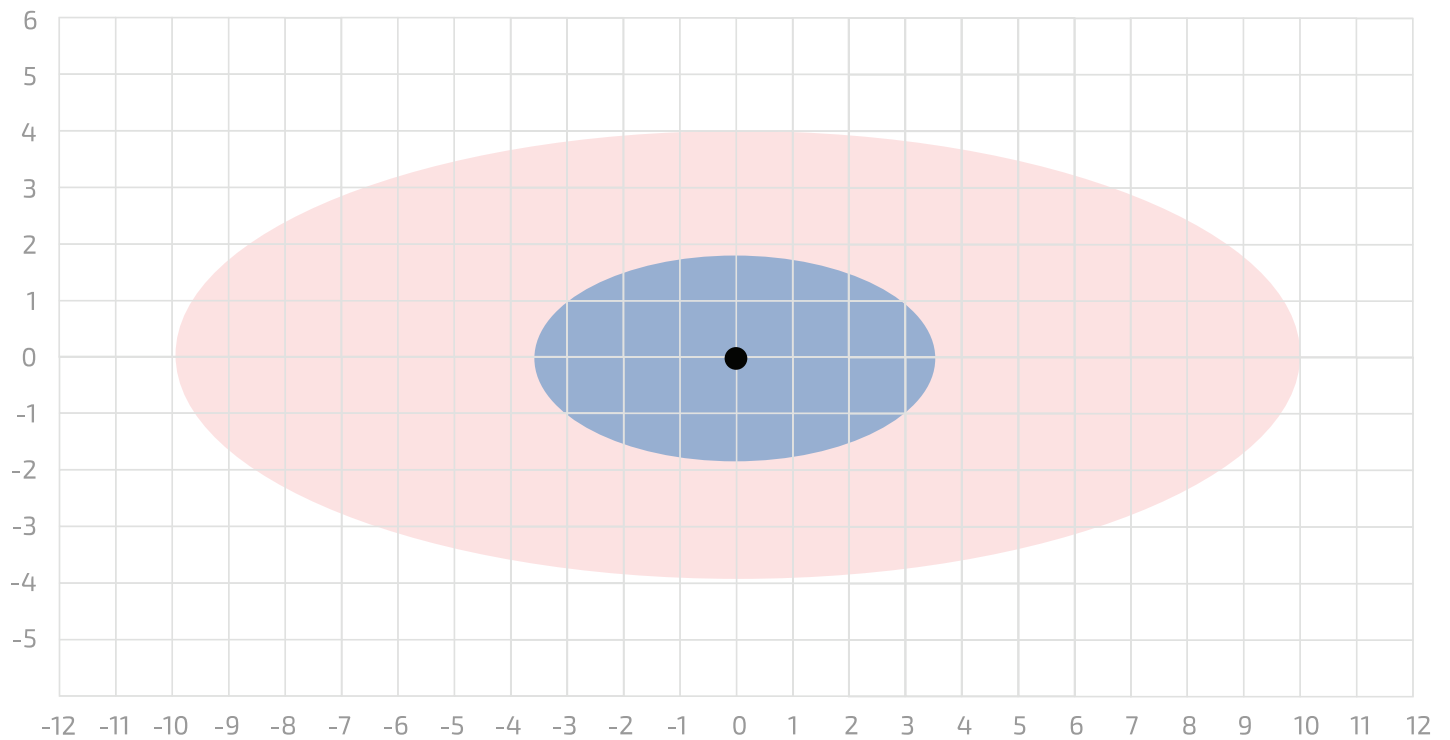

## Wall mounted radar range

Default sensitive value, it's suggested at around 1.8 meters of height. When you use and install the devices on the wall, please keep a tilt of 15 degrees to the wall. The radar detects area showed on the below graph for reference.

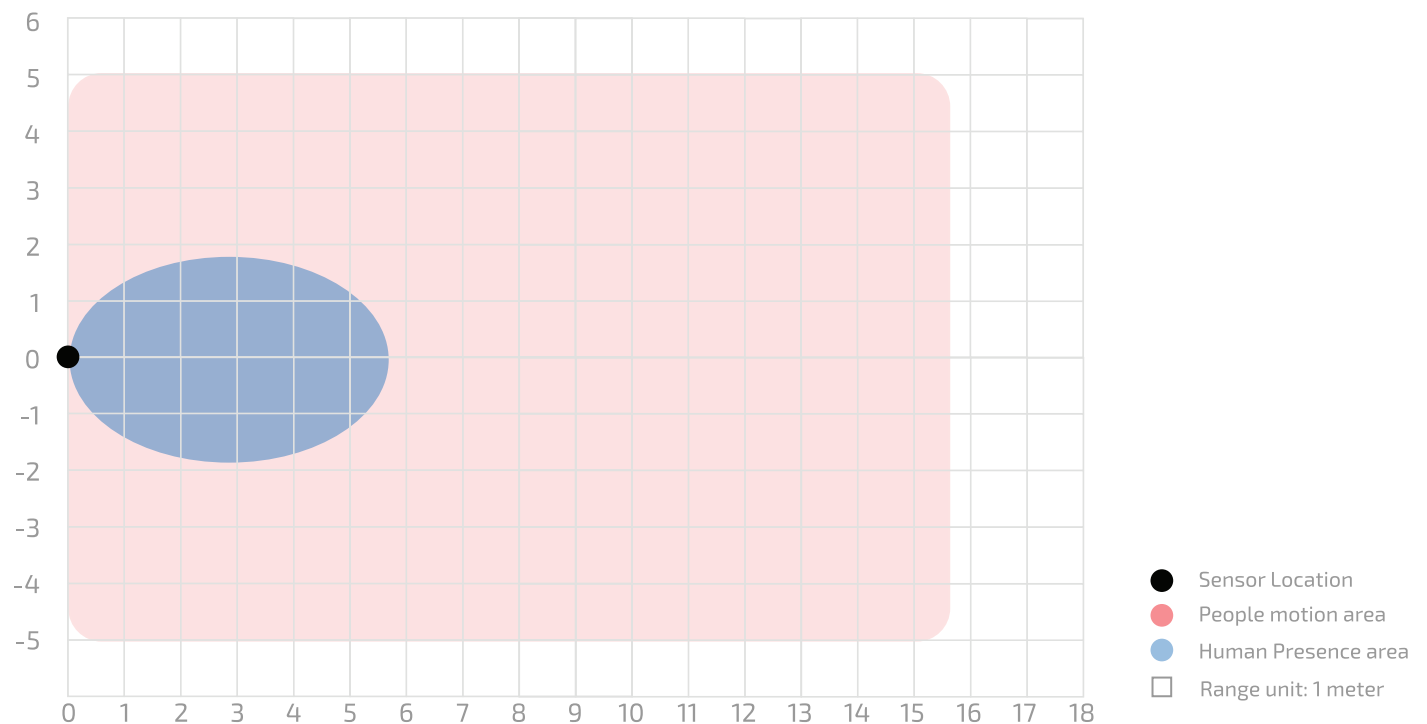

# Installation diagrams

## Wall mount installation

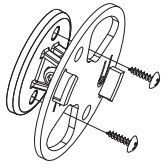

STEP 1: Fix the body to the wall with the 2 provided screws

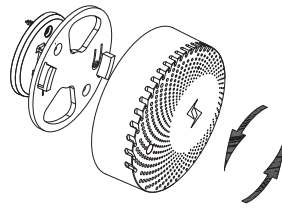

STEP 2: Clip the body onto the main base plate.

## Ceiling mount

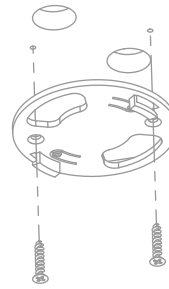

STEP 1: Fix the holder to the ceiling with the 2 provided screws

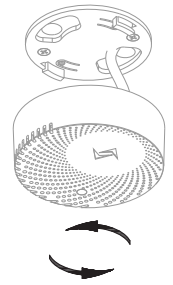

STEP 2: Clip the body onto the main base plate.

**Note:** the wall mounted version has a 15° tilt adjustment when mounted on its holding plate

## Configuration options

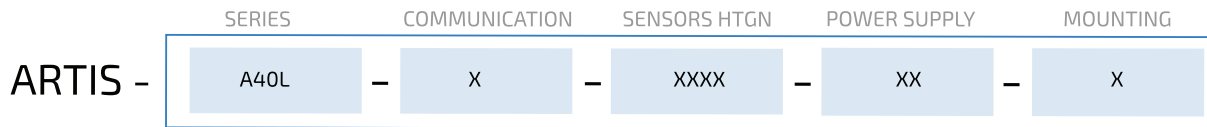

E.g. Artis A40LB1011D2C means Artis sensor with long range 24GHz radar sensor, light sensor, temperature, humidity and pressure sensor, gas sensor, and noise sensor, which is powered by DC5V, mounted on ceiling

### Series

- A40 24Ghz Radar Sensor - Short Range
- A40L 24Ghz Radar Sensor - Long Range
- A80 Ultra-Wide Band Sensor

### Communication

- B Wireless mesh
- L LoRa
- Z Zigbee
- T Thread

### Sensors

- H: Temperature, humidity and pressure sensor..... 0/1
- T: Temperature sensor..... 0/1
- G: Gas sensor..... 0/1
- N: Noise sensor..... 0/1

### Power supply

- D1 12-48Vdc
- D2 5Vdc

### Mounting

- W Wall
- C Ceiling



**Germany**  
 Stahlgruberring 36  
 81829 Munich,  
 Germany  
 (49) 89 215522535

**Hong Kong**  
 Unit 725, 7/F, Building 19W,  
 No. 19 Science Park West Avenue,  
 Hong Kong  
 (852) 6575 0495

**China**  
 7 Ganli 6th rd, 2F Building 2,  
 Longgang district, 518000  
 Shenzhen, China  
 (86) 755 2891 1623

**Disclaimer:**  
 Sycra® reserves the right to make changes to this product at any time without prior notice and such modification shall be effective immediately. For more information and details, visit [www.sycratech.com](http://www.sycratech.com) or contact [info@sycratech.com](mailto:info@sycratech.com).